

T350 3.5 Tonne Power Swivel

KEY FEATURES & BENEFITS - MACH2074



The Thwaites T350 Power Swivel, Stage V dumper is manufactured with contractors and hirers in mind – ensuring operator safety, reducing risk on site and improving performance. Powered by a 33.3 kW Yanmar engine, delivering 142 Nm max torque for optimum traction and control, this machine is driven by a Hydrostatic transmission, making it simple and straightforward to operate.

This sturdy and robust machine has a fully welded 5 mm steel plate skip to the mouth and sides with reinforced box section fitted to minimise skip damage. The Power Swivel skip enables a 90° rotation left and right, allowing the machine easier access to tip loads in restricted areas, giving the operator greater control and reducing risk on site.

Each T350 Power Swivel dumper is supplied as standard with a Spring Activated Hydraulic Release (SAHR) Handbrake, ROPS frame, towing bracket, full LED road lights including daylight running lights, LED beacon and a reverse alarm. Optional extras include road mirrors, wheel nut indicators, GPS speedometer and a Trackunit.

Easy to service and maintain with market leading residuals.

Safe, compliant and competitive.



Snap this QR code from your smart phone for more information



Thwaites

Thwaites Ltd, Leamington Spa,
Warwickshire, CV32 7NQ, England
Tel +44 (0)1926 422471

www.thwaitesdumpers.co.uk



GET THE JOB DONE.

T350 3.5 Tonne Power Swivel

DIMENSIONS & SPECIFICATIONS - MACH2074

(mm)

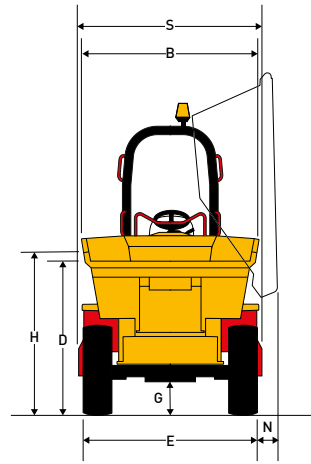
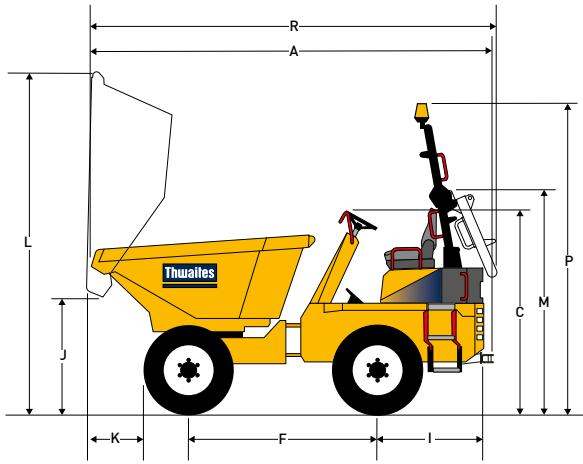

A	4037	N	242
B	1770	P	3288
C	2112	R	4050
D	1507	S	1850
E	1750		
F	1978		
G	279		
H	1617		
I	1111		
J	1205		
K	491		
L	3352		
M	2297		

Weight	Unladen	2940 kg
	Shipping	2913 kg

Capacities	Max safe load	3500 kg
	Heaped	1870 litres
	Struck	1480 litres
	Water	1015 litres

Engine

- › Yanmar 3TNV86CHT, water-cooled, 3-cylinder, charged air cooled turbo common rail diesel with direct-injection and DPF
- › Power 33.3 kW/45 bhp at 2600 rpm
- › Torque 142 Nm (105 lbf ft).

Noise Levels

- › Operator's ear 84 LpA / airborne level 101 LwA

Transmission

- › Hydrostatic with high/low speed range, column mounted directional control lever and inching facility

Speeds	Forward and Reverse	
	Low	0 - 8.8 km/h (5.5 mph)
	High	0 - 23.8 km/h (14.8 mph)

Brakes and Axles

- › Totally enclosed multiplate oil-immersed discs mounted on rear axle & auto wear adjustment
- › Hand operated parking brake (SAHR)

Kinglink Chassis

- › Constructed from folded steel plate, with three point Kinglink giving articulation and oscillation for better stability, traction and safety on site

Skip

- › Hydraulically operated, 6 mm steel plate all round
- › Skip mouth & sides reinforced with box sections
- › Power Swivel skip enables a 180° rotation

Seating & Controls

- › Adjustable suspension seat with high-vis seat belt
- › LED warning lights for all critical functions

Service Access

- › Lockable engine cover for ground level service points
- › Rear access door incorporates the battery, power distribution board and air cleaner

Electrics

- › Fuse & relay panels housed in easy to access positions
- › All electrical components water resistant to IP67 rating

Steering and Hydraulics

- › Hydraulic power steering
- › Return line filtration for all services
- › Hydraulic test point fitted as standard

Tank Capacities	Fuel	44 litres
	Hydraulic	44 litres

Turning Circle	8.00m
----------------	-------

Standard Equipment

- › Full LED road lighting incl. DRL (Daylight Running Lights)
- › Camera and dashpanel monitor
- › LED amber beacon
- › Fan guard
- › Reverse alarm

Optional Equipment

- › Road mirrors
- › GPS speedometer
- › Wheel nut indicator
- › Heated seat

Thwaites

Thwaites Ltd. Leamington Spa,
Warwickshire, CV32 7NQ. England
Tel +44 (0)1926 422471

www.thwaitesdumpers.co.uk



Images are representative, but specific details or equipment may vary by country. We reserve the right to change any and all specifications without prior notice. 08/2021